

# FLAME

## ARPEGGIATOR 2013 + X-2013



# MANUAL

Version 1.07

## Inhalt

<b>1. Short description .....</b>	<b>3</b>
<b>2. Hardware / Connections .....</b>	<b>4</b>
2.1-2 Connection to the modular system (Doepfer Bus), X-2013 xpander-module	<b>4</b>
2.3 Module frontpanel overview, Sequencer structure	<b>5</b>
<b>3. Function .....</b>	<b>6</b>
3.1 Structure schematics	<b>6</b>
3.2 Menu ARP / BASS (Arpeggiator tracks)	<b>7</b>
<b>4. Menu ARP / BASS .....</b>	<b>7</b>
4.1 ARP / BASS functions with parameters	<b>7</b>
4.2 Mode	<b>8</b>
4.3 Converse, Noterepeat	<b>10</b>
4.4 - 4.6 Range, Glide, Sequence, mirrored sequence	<b>11</b>
4.6 Edit sequence	<b>12</b>
4.7 - 4.9 Clock, Gate, Velocity	<b>13</b>
4.10 - 4.13 Sequ-Mode, Sequ-Reset, Out-Gate, Out-CV	<b>14</b>
<b>5. Menu CHORD / SCALE .....</b>	<b>15</b>
5.1 Description (MENUS, KEYNOTE), HOLD function	<b>15</b>
5.2 Table of preset chords and scales	<b>16</b>
<b>6. Menu List .....</b>	<b>17</b>
6.1 Structure Arp / Bass list, Transpose	<b>17</b>
6.2 Edit Arp / Bass list	<b>18</b>
6.3 PLAYLIST MENU	<b>19</b>
<b>7. Menu Setup .....</b>	<b>20</b>
7.1 Tune-Mode, USER-Inputs	<b>20</b>
7.2 USER-Inputs: Parameter overview	<b>21</b>
<b>8. Menu X-OUT .....</b>	<b>22</b>
8.1 Sequence, Clock, Gate	<b>22</b>
<b>9. Menu MIDI .....</b>	<b>23</b>
9.1 Tempo, Sync, MIDI-clock-Divider, MIDI-channel-settings	<b>23</b>
9.2 Table of MIDI-controllers, Keyboard splitzone, MIDI chord	<b>24</b>
<b>10. Appendix .....</b>	<b>25</b>

# 1. Short description

## ARPEGGIATOR-2013 Module

The module is a two-channel arpeggiator with separately analogue outputs for notes and two optional movable outputs for the sequence clock and the velocity. Both arpeggio tracks (referred to as "ARP" and "BASS") play notes also via MIDI-out (different MIDI-channels 1 and 2). The first four notes of the ARP track notebuffer forms the chord. The chord analogue outputs are the CV-outputs 1-4 (notes 1-4). The MIDI-channel of the transmitted chord is channel 3.

Use the module-keyboard for setting the chord/scale notes. The one octave of the module-keyboard can move over four octaves (KEYZONE). It's possible to load preset chords/scales and user defined chords/scales (organized respectively 16 user patches U01..U16).

The arpeggiator mode included 9 arpeggio play modes with additional different running directions, like up, down, updown, downup and different variations of noterepeats.

You can control functions (as well as Arpeggio-Mode, Noterepeat, Octave-Range, Sequence-Pattern, Transpose or others) via CV-inputs. Two CV-inputs (USER-1 and USER-2) can be set with individual functions.

The internal sequencer can be synchronized from external MIDI-clock or external Trigger clock. The module included two MIDI-clock divider for incoming or transmitted MIDI-clock (halftime playing sequencer and/or external sequencers).

Each of all 10 sequencer tracks (ARP, BASS, X-OUT 1-8) included a clockdivider (based of internal or external MIDI-clock ticks) and/or a different sequence pattern.

The CV-input LIST can be easily control the both arpeggio tracks ARP and BASS. The 12 list places can be used for auto-playing different chords/scales of ARP and BASS tracks with separately keynotes (chord/scale sequencer).

All individual settings can be saved permanently (to the internal EEPROM).

## X-2013 Xpander-module

The X-2013 module features additional 8 clock/gate outputs and the jacks for MIDI-In, MIDI-Out and MIDI Thru. The 8 clock/gate outputs can be used like 8 independently clockdivider or sequencer tracks with internal or external MIDI-clock. Each output features different sequence-pattern, clock or gate of the track and send a fix MIDI note on MIDI channel 10.

Advice:

You can use the Arpeggiator-module without the X-2013 module, but without MIDI-options and the additional clock outputs.

Firmware versions can be loaded with the provided usb programming adapter (only with PC with Atmel FLIP).

## 2. Hardware / Connections

### 2.1 Connection to the modular system (Doepfer bus)

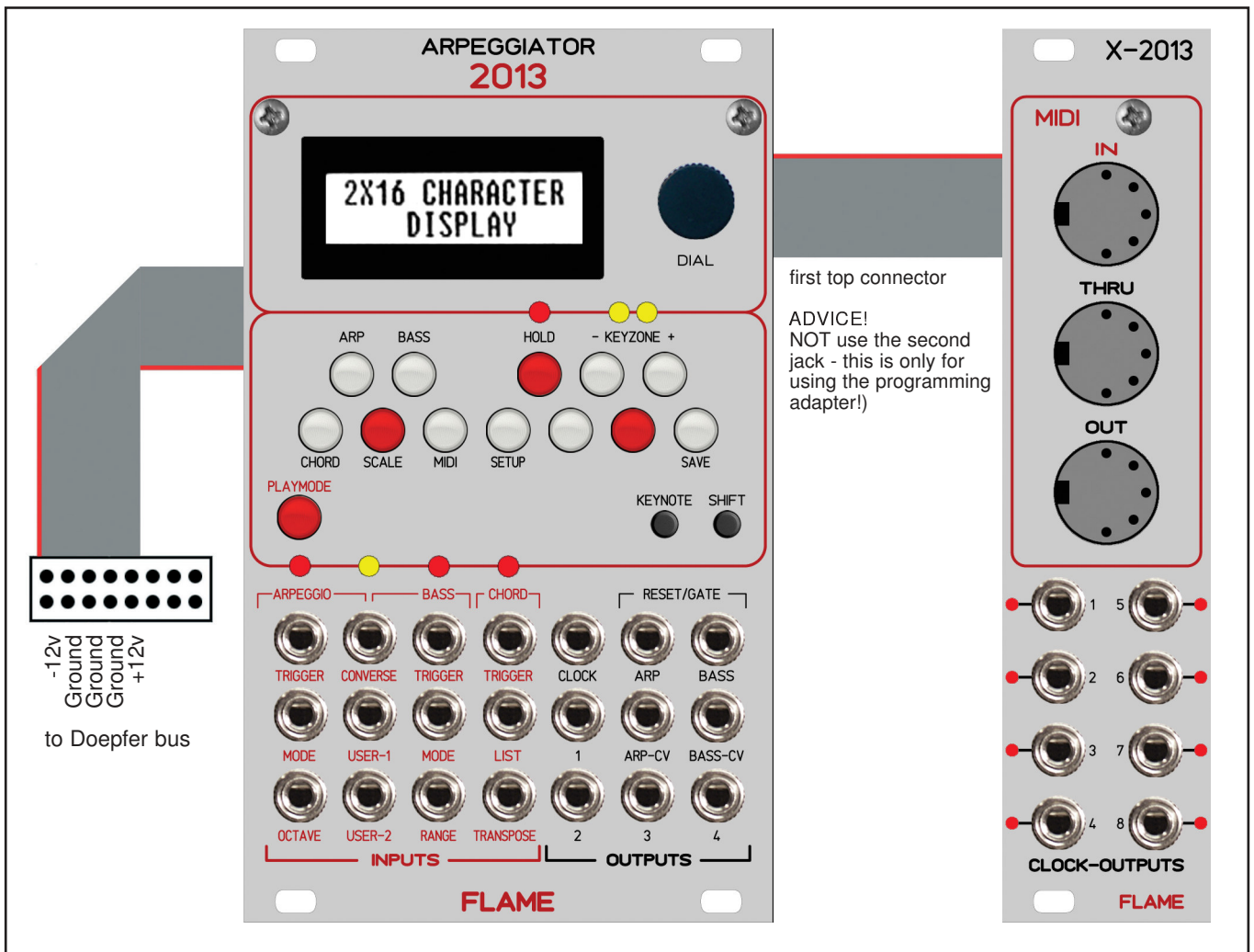

The module is delivered with a connected ribbon cable for the Doepfer bus. The red lead marks -12 volt. Connecting the module please note the right polarity!

If the module is poled accidentally wrong safety diodes avoid the immediate destruction of the module but further damages cannot be expected. So please pay attention: Check the connection various times before switching on!

**Advice !** Please check the correct connection several times before switching-on the module!

**Please note:** All the miniature precision rulers at the board are adjusted exactly to the correct justification of the reference voltage for the AD and DA converter. It must not be readjusted! The module would not more run precisely. A probably to big voltage could also damage the circuits.

### 2.2 Connecting X-2013 Xpander-module

We deliver both modules with connected cable. The X-2013 module is connected at the top first connector on right side. The subjacent second connector is the port for the provided programming adapter (firmware updates)

**Advice !**

Do NOT connected the programming adapter with the top port - this destroy the programming adapter!

## 2.3 Module frontpanel overview

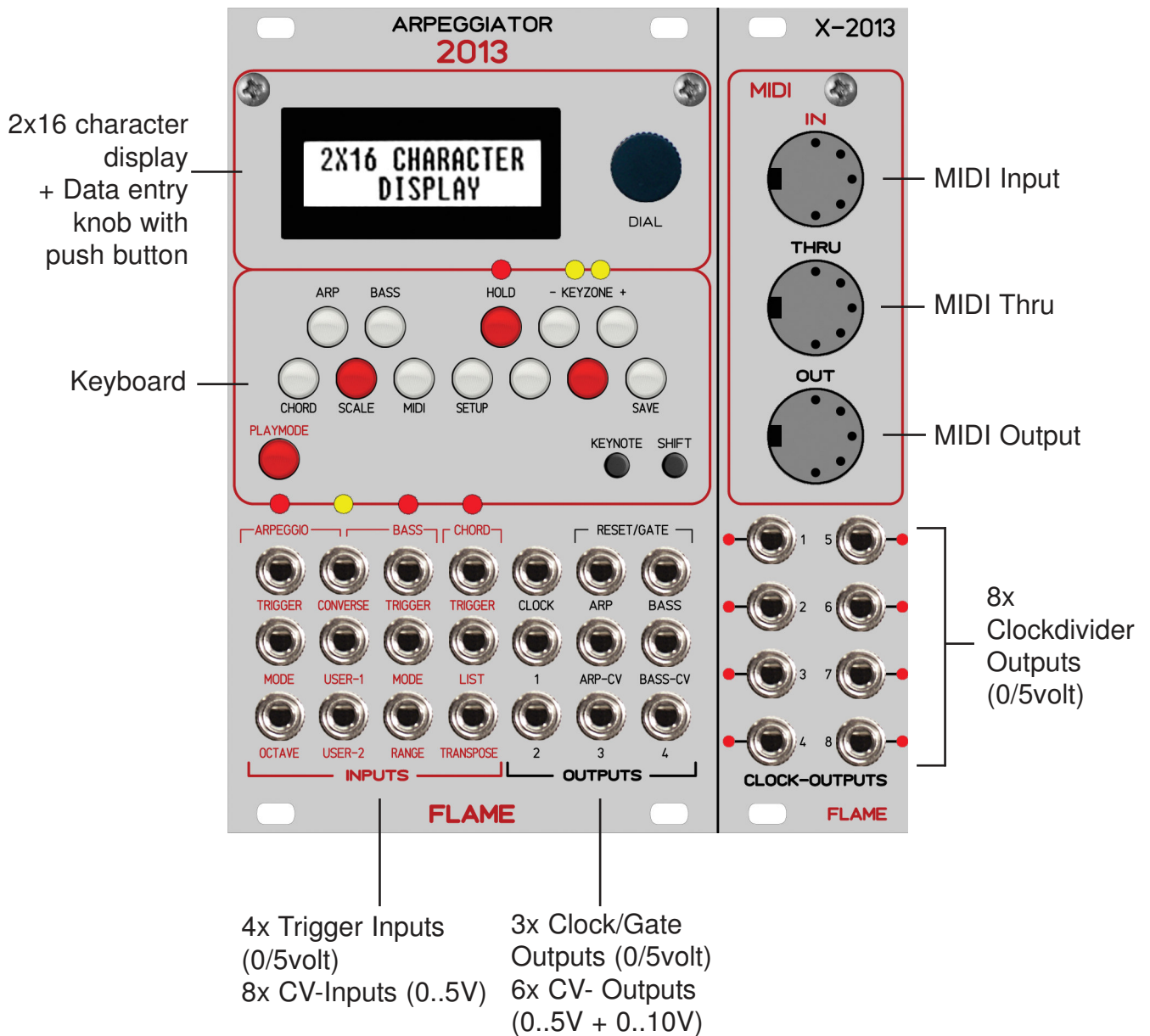

### Sequencer structure:

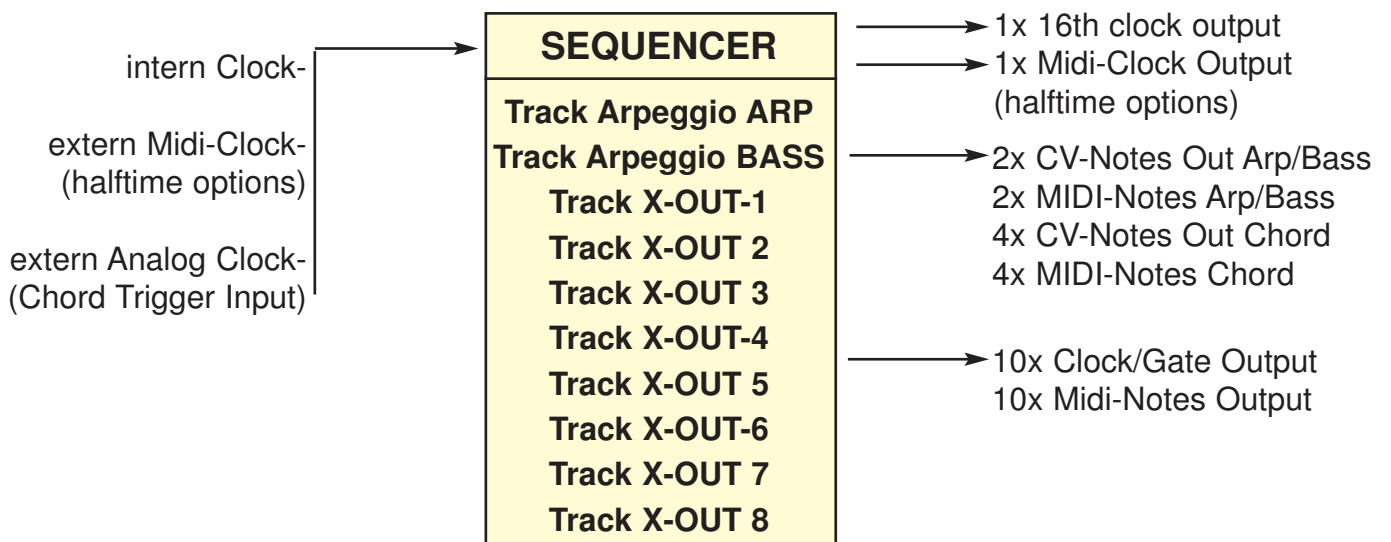

# 3. FUNCTION

## 3.1 STRUCTURE SCHEMATA

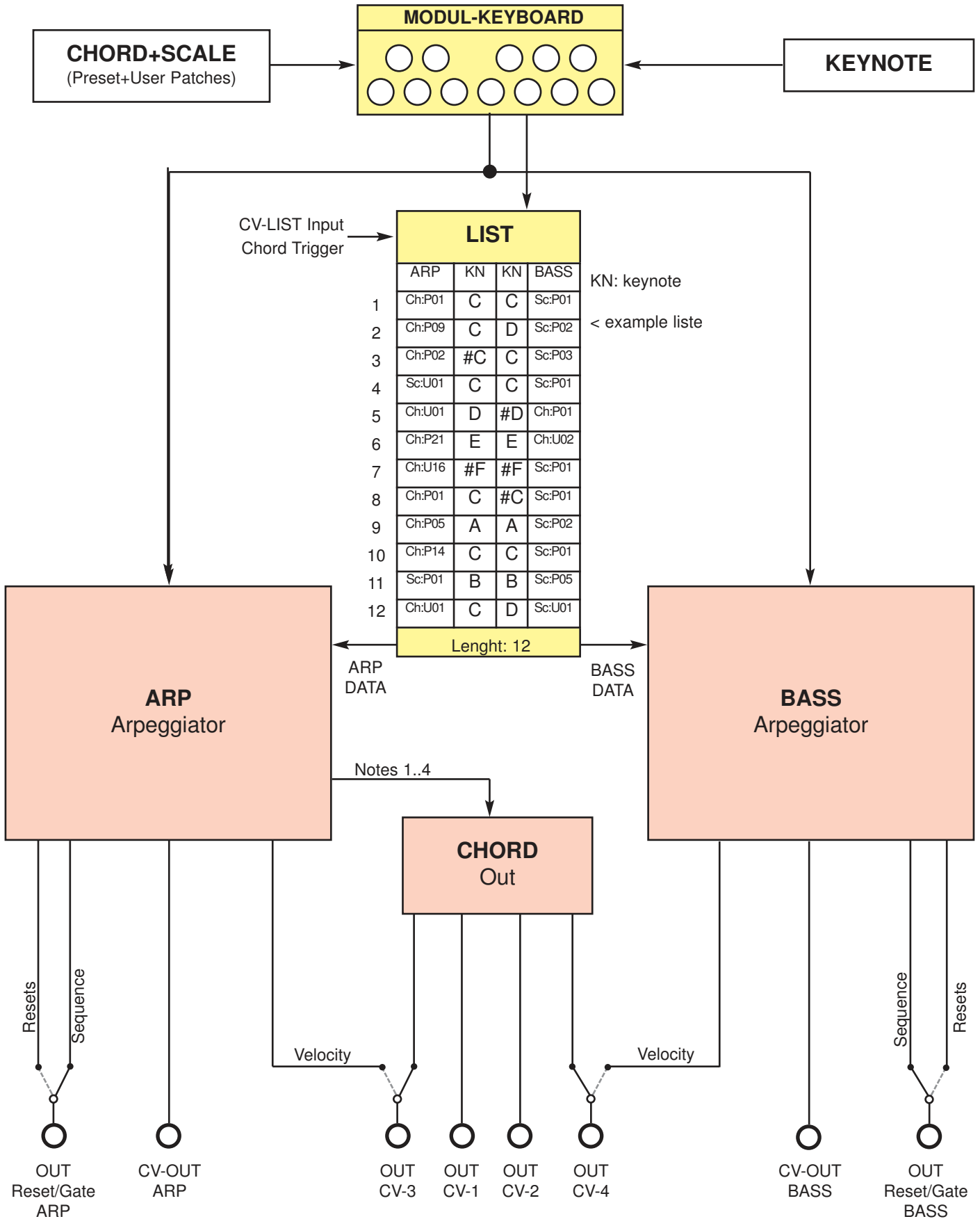

## 4. MENU ARP / BASS

### Call MENU ARP:

Push down Key SHIFT and Key ARP ("CIS")

### Call MENU BASS:

Push down Key SHIFT and Key BASS ("DIS")

Change also the MAINMENU while push down and turn the data-entry-knob!

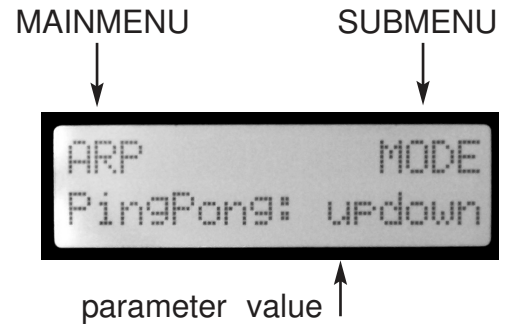

### Call SubMenus and set values:

Toggle between Submenu selection and value selection: Push data-entry-knob

Blink Submenu ON: you select the submenu of your choice by turning the data-entryknob

Blinking OFF: you select the parameter of your choice by turning the data-entryknob

Both menus ARP and BASS are identical except the setting of the CV-output VELOCITY:

Velocity ARP output CV-out 3

Velocity BASS output CV-out 4

You can set directly notes on/off (please note HOLD option).

Please use for loading preset/user chords/scales the menus CHORD and SCALE (see below).

### 4.1 Menu ARP / BASS: Functions with parameters

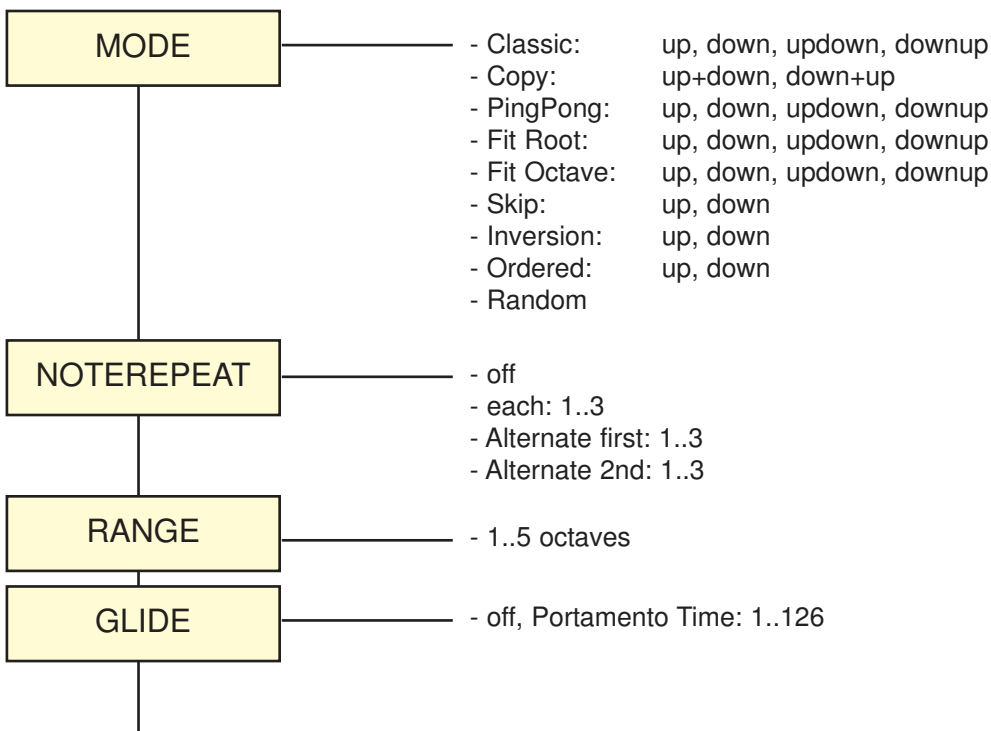

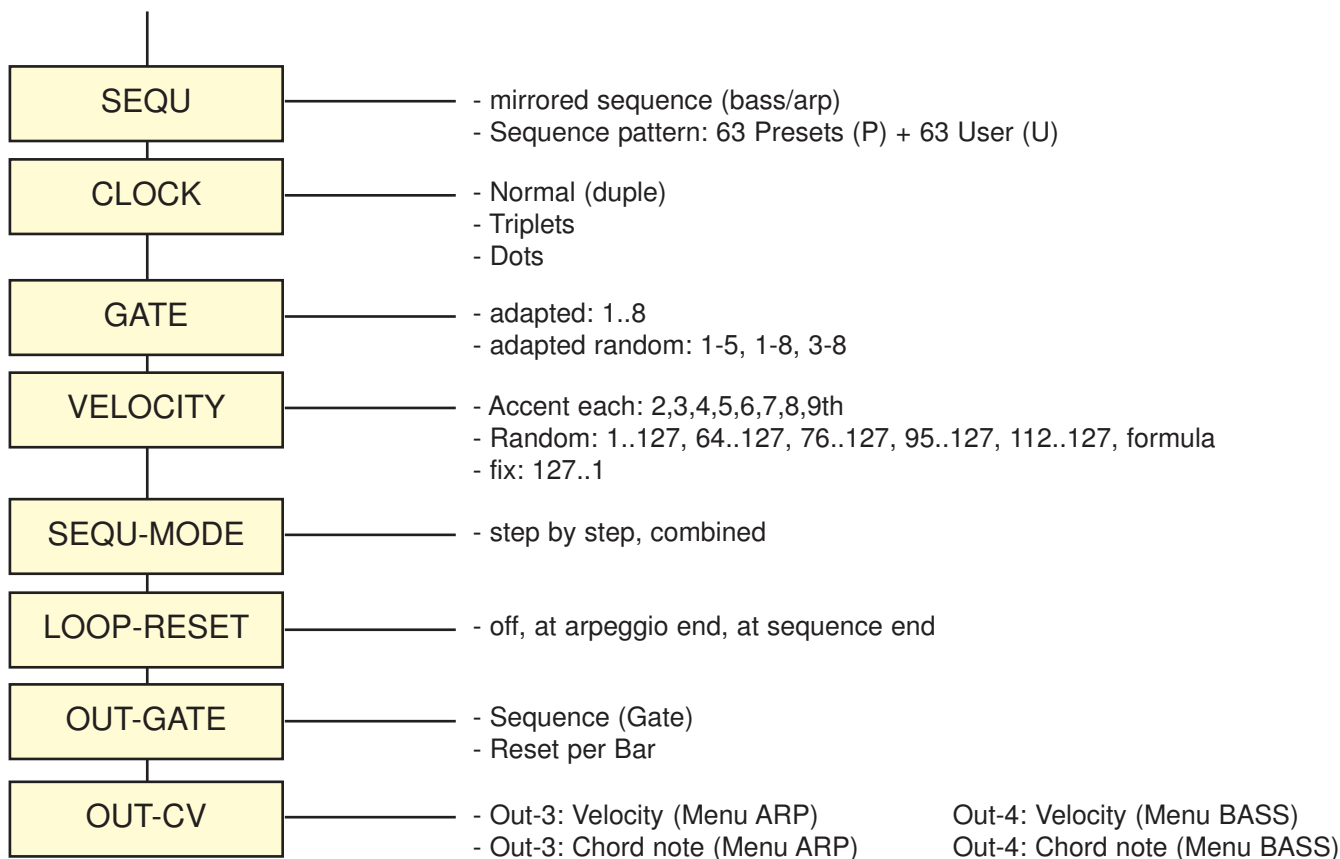

## 4.2 Menu ARP / BASS: MODE

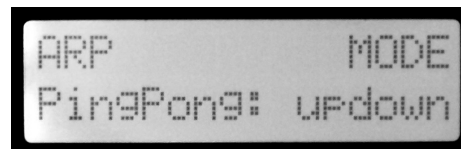

MODE = Play algorithm of the arpeggios

### 1. MODE: CLASSIC

#### UP:

classic mode plays notes from down to up and loop ...

#### DOWN:

classic mode plays notes from up to down and loop ...

#### UPDOWN:

arpeggion begins down and play alternated updown in loop ...

#### DOWNUP:

arpeggio begins up and play alternated downup in loop...

### 2. MODE: COPY

#### UP+DOWN:

plays mode Classic UP and DOWN in series.

(as distinguished from CLASSIC UPDOWN: the Most High and the deepest notes plays done twice).

#### DOWN+UP:

plays mode Classic DOWN and UP in series.

(as distinguished from CLASSIC UPDOWN: the Most High and the deepest notes plays done twice).



### 3. MODE: PINGPONG

Plays notes alternately from down and up:

Example chord C-major 6, pressed notes: C E G A

**UP:** C A E G

**DOWN:** A C G E

**UPDOWN:** C A E G A C G E

**DOWNUP:** A C G E C A E G

### 4. MODE: FIT ROOT

Insert root note (deepest note):

Example chord C-major 6, pressed notes: C E G A

**UP:** C E C G C A

**DOWN:** A C G C E C

**UPDOWN:** C E C G C A C G C E

**DOWN:** A C G C E C E C G C

### 5. MODE: FIT OCTAVE

Insert root note (deepest note), transposed one octave higher:

Example chord C-major 6, pressed notes: C E G A

**UP:** C C1 E C1 G C1 A C1

**DOWN:** A C1 G C1 E C1 C C1

**UPDOWN:** C C1 E C1 G C1 A C1 A C1 G C1 E C1 C C1

**DOWN:** A C1 G C1 E C1 C C1 C C1 E C1 G C1 A C1

### 6. MODE: SKIP

Skipping notes:

Example chord C-major 6, pressed notes: C E G A

**UP:** C E G A E G A C G A C E A C E G

**DOWN:** A G E C G E C A E C A G C A G E

### 7. MODE: INVERSION

Plays threefold chord inversions: root, 1st and 2nd inversion:

Example chord C-major 6, pressed notes: C E G A

**UP:** C E G A E G A C1 G A C1 E1

**DOWN:** E1 C1 A G C1 A G E A G E C

## 8. MODE: ORDERED

Plays notes in order of input (sort OFF).

**UP:** normally.

**DOWN:** UP backwards

## 9. MODE: RANDOM

Plays notes in randomized order.

## CONVERSE (not available,if SYNC="ARP+BASS Trigger")

Trigger-Input "CONVERSE" set the MODE of Arpeggio ARP converse to the MODE of BASS. Both Arpeggios plays then in converse mode.

Example:

CONVERSE OFF: BASS Mode: classic up >> ARP Mode: Fit root updown

CONVERSE ON: BASS Mode: classic up >> ARP Mode: classic down (converse)

## 4.3 Menu ARP / BASS: NOTEREPEAT

NOTEREPEAT of playing notes.

### OFF

Don't repeat notes:

Beispiel: C D E      Noterepeat OFF: C D E

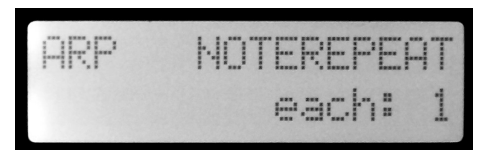

### EACH (1..3)

Each notes repeat 1, 2 or 3x. (If Repeat= 3 then the note plays four times!)

Example: C D E      Noterepeat Each: 1      CC DD EE CC DD EE ...  
Noterepeat Each: 2      CCC DDD EEE CCC DDD EEE ...

### ALTERNATE 1st (1..3)

Each second notes (beginning from first note) repeat 1, 2 or 3x.

Example: C D E      Noterepeat Alternate 1st: 2      CCC D EEE C DDD E ...  
Noterepeat Alternate 1st: 3      CCCC D EEEE C DDDD E ...

### ALTERNATE 2nd (1..3)

Each second notes (beginning from second note) repeat 1, 2 or 3x.

Example: C D E      Noterepeat Alternate 2nd: 1      C DD E CC D EE ...  
Noterepeat Alternate 2nd: 2      C DDD E CCC D EEE ...

#### 4.4 Menu ARP / BASS: RANGE

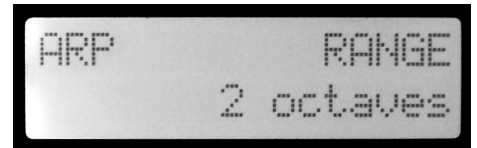

RANGE determines the range of the single notes in octaves. When it is set to 1 octave, the note list will be played back in the same octave as originally entered. Greater values mean that the note list is repeated in higher or lower octaves. If you play notes that span more than one octave, they are still kept in the note list and played back before the note list is transposed.

RANGE values: 1..5 octaves

#### 4.5 Menu ARP / BASS: GLIDE

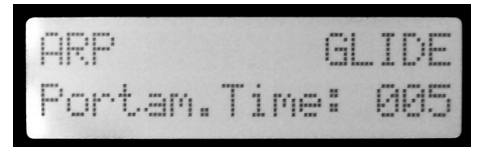

GLIDE determines the portamento time of the notes (from CV-outputs), die über den CV-Ausgang gespielt werden eingestellt. ( Advice: Not the Portamento of MIDI-notes! ).

GLIDE values:                   - OFF (portamento is deactiv)  
                                   - Portam.Time: 001 ...126  
   (small values: fast, larger values: slowly)

The speed of the portamento is automatically conform in different tempi.  
 (internal tempo only)

#### 4.6 Menu ARP / BASS: SEQ (SEQUENCE PATTERN)

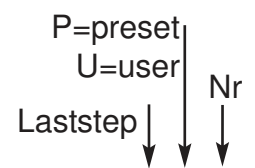

Here sets or edit the sequence pattern that is used for generating the arpeggio. You can use 63 preset ROM sequence pattern and 63 user sequence pattern.

Laststep is the length of the pattern (number of steps):

**Example:**

16P08: 16 steps Preset Sequence Nr. 08

05U01: 5 steps User Sequence Nr. 01

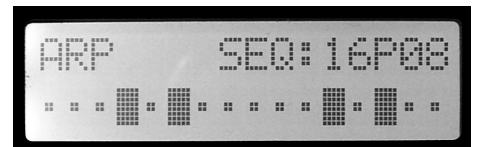

The first three patterns have this functions:

**Pattern 16P00:** mirrored sequence

**Example:**

BASS Sequence plays this pattern:



ARP with "mirrored sequBass" plays the mirrored BASS pattern:



**Sequence 16P01 don't play steps (all steps of pattern Off):**

The arpeggiator track is OFF.

**Sequence 16P02 play each step:**

The arpeggiator plays back a continuous sequence of notes with the current Clock setting.

You can set also the sequence pattern with CV-inputs USER (see below Menu SETUP)

### PATTERN DIRECTION

	<b>Preset Pattern</b>	<b>User Pattern</b>
mirrored	16P00	
16 Steps Length:	16P01..16P32	16U01..16U32
12 Steps Length:	12P01..12P31	12U01..12U31
5 Steps Length:	05P01..05P08	05U01..05U08
7 Steps Length:	07P01..07P08	07U01..07U08
9 Steps Length:	09P01..09P08	09U01..09U08
10 Steps Length:	10P01..10P08	10U01..10U08
11 Steps Length:	11P01..11P08	11U01..11U08
13 Steps Length:	13P01..13P08	13U01..13U08
14 Steps Length:	14P01..14P08	14U01..14U08
15 Steps Length:	15P01..15P08	15U01..15U08

### EDIT SEQUENCE PATTERN

**How you can create sequence pattern and save the pattern on user memory cell:**

1. At first go to the menu "ARP SEQ" or "BASS SEQ".
2. Select the pattern with relevant Laststep (step length of pattern).
3. Set or clear the steps of the sequence with the lower note keys C-B and CIS.
  - Step 1 or 9 > Key C
  - Step 2 or 10 > Key CIS
  - Step 3 or 11 > Key D
  - Step 4 or 12 > Key E
  - Step 5 or 13 > Key F
  - Step 6 or 14 > Key G
  - Step 7 or 15 > Key A
  - Step 8 or 16 > Key B
4. Toggle between step groups 1-8 and 9-16 with the keys #G and #A (Keyzone) . The LCD displays the complete sequence. The illuminated keys displays the set/cleared steps of the selected group.
5. Store the sequence: Go to the SAVE menu (push keys SHIFT+SAVE). Select a memory cell (turn the data-entry-knob) and push key "KEYNOTE".

**Advice:** You can only store in the same Laststep group.

## 4.7 Menu ARP / BASS: CLOCK

(not available,if SYNC="ARP+BASS Trigger")

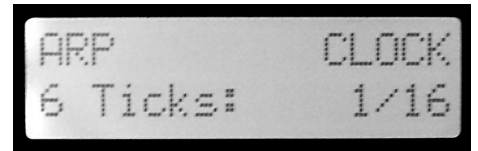

Sets the note value for the steps of the rhythm pattern (SEQU pattern) in a range from one tick to one bar (whole note). Additional triplets and dotted notes are available for every note value.

Examples: 6 Ticks: 1/16      16th notes  
9 Ticks: 1/16 dot      16th dotted notes  
4 Ticks: 1/16 tri      16th triplets

## 4.8 Menu ARP / BASS: GATE

(not available,if SYNC="ARP+BASS Trigger")

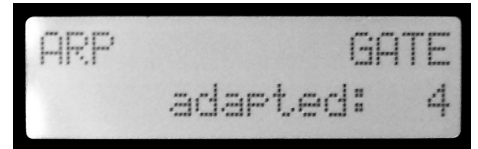

GATE is the time between Note-On and Note-Off. The GATE time values are adapted in relation to the Clock of the sequence ("adapted").

The Reset/gate outputs from ARP and BASS plays the clock/gate sequences.

For that purpose you have to set the value of submenu "OUT-GATE" to "Sequencer(Gate)" (see below).

Following values are always definitely:

adapted: 1      GATE time is always the time of 1 tick.  
adapted: 8      GATE time is always the time of value CLOCK of the sequence.

With "adapted:8" you can play notes without note off (bonded):

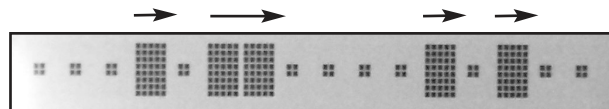

## 4.9 Menu ARP / BASS: VELOCITY

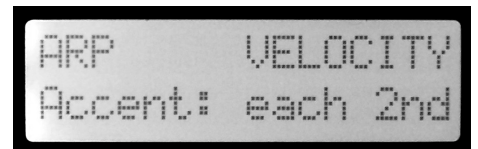

Determined the Velocity of transmitted MIDI-notes of the arpeggio. Also you can issue the velocity as voltage 0..5volt on CV-output 3 (velocity of ARP track) and CV-output 4 (velocity of BASS track). For that purpose you have to set the value of submenu "OUT-CV" to "Velocity" (see below).

Following values are possible:

FIX:            1..127            fix value between 1..127  
ACCENT:        each 2nd..9th      accent  
RANDOM:        x..127            range of randomized velocity  
RANDOM:        formula            random formula

#### 4.10 Menu ARP / BASS: SEQU-MODE

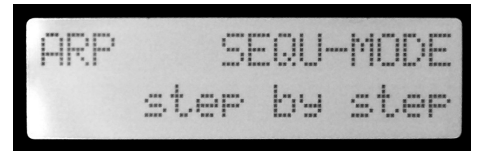

SEQUENCE-MODE determines the match of the arpeggio steps with steps of the sequence.

##### step by step:

Each step of sequence play the next note of the arpeggio (normaly mode).

Example:

Arpeggio notes: C D E F G A H ...

Sequence  
play:

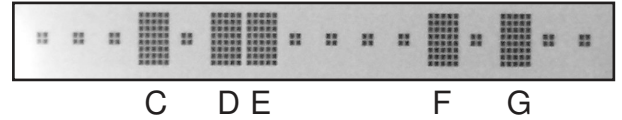

##### combined :

The “combined mode” merge the sequence with the arpeggio notes.

Example:

Arpeggio notes: C D E F G A H ...

Sequence  
play:  
than:

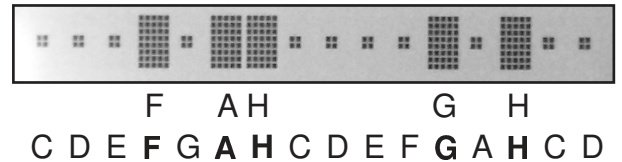

#### 4.11 Menu ARP / BASS: LOOP-RESET

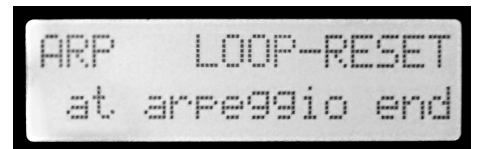

OFF: no reset

AT ARPEGGIO END: Loop Reset at arpeggio end

AT SEQUENCE END: Loop Reset at sequence pattern end

#### 4.12 Menu ARP / BASS: OUT-GATE

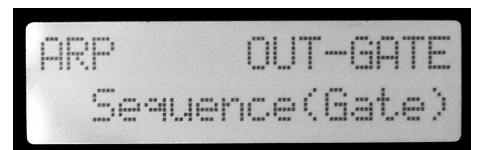

SEQUENCE(GATE): Sequence output over Reset/Gate output jack

RESET PER BAR: Reset impulse per bar over Reset/Gate output jack

(available only SEQUENCE(GATE), if SYNC=Arp+Bass Trigger)

#### 4.13 Menu ARP / BASS: OUT-CV

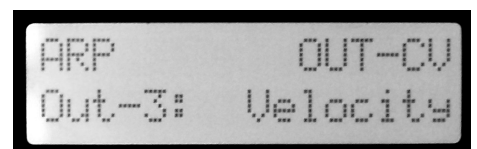

VELOCITY: Velocity voltage output over CV-3 output jack (BASS CV-4 output)

CHORD NOTE: Chord note 3 output over CV-3 output jack  
(BASS: chord note 4 over CV-4 output jack)

## 5. MENU CHORD / SCALE

### 5.1 Description

#### Call MENU CHORD:

Push down Key SHIFT and Key CHORD ("C")

Change also the MAINMENU while push down and turn the data-entry-knob!

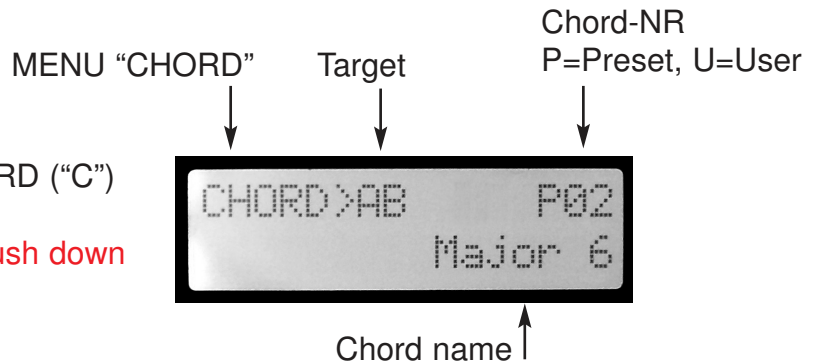

#### Call MENU SCALE:

Push down Key SHIFT and Key SCALE ("D")

Change also the MAINMENU while push down and turn the data-entry-knob!

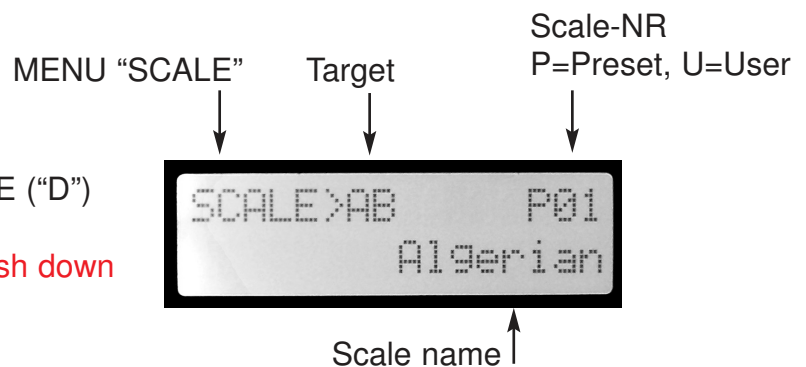

#### Set the KEYNOTE:

Push and Hold down key "KEYNOTE " and push the key for set the Keynote. The LED of the key displays the Keynote.

You found the keynotes of ARP and BASS in the second row of the Keynote menu:



#### Target:

"Target" means, that the notes are loaded likewise to ARP and BASS buffer.

For setting different notes in ARP / BASS buffer please use the LIST function (see below).

#### Load preset/user chords/scales:

Turn the data-entry-knob.

Notes begins to load (automatically transposed) to the octave 1 of the modul keyboard.

You can see the notes on the LEDs of the keys.

While loading notes, "HOLD" will be set to "ON" automatically. You can clear all notes if you set the "HOLD" function "OFF" (Push and hold down key SHIFT and HOLD).

## 5.2 Preset chords

## Preset scales

NR	NAME	SIZE (notes)	NR	NAME	SIZE (notes)
P01	Major	3	P01	Agerian	8
P02	Major 6	4	P02	Arabian	6
P03	Major 7	4	P03	Balinese	5
P04	Major 7b5	4	P04	Blues major	6
P05	Major 7#5	4	P05	Blues minor	6
P06	add 2	4	P06	Byzantine	7
P07	add 4	4	P07	Chromatic	12
P08	add 9	4	P08	Diatonic	5
P09	Diminished	3	P09	Double Harmonic	7
P10	7	4	P10	Enigmatic	7
P11	7b5	4	P11	Egyptian	5
P12	sus 4	3	P12	Hindustan	7
P13	sus 4 sus 2	4	P13	Hungarian major	7
P14	Pentatonic	4	P14	Hungarian minor	7
P15	Minor	3	P15	Japan: hira-yoshi	5
P16	Minor 6	4	P16	Japan: iwato-yoshi	5
P17	Minor 7	4	P17	Japan: kumoi-yoshi	5
P18	Minor 7 b5	4	P18	Japan: insen	5
P19	Minor 7 #5	4	P19	Japan: yosen	5
P20	Minor add 2	4	P20	Japan: ritsusen	5
P21	Minor add 4	4	P21	Japan: ryosen	5
P22	Minor add 9	3	P22	major Locrian	7
P23	Diminished 7	4	P23	super Locrian	7
P24	half dim 7	4	P24	Lydian minor	7
P25	Augmented	3	P25	Major	7
P26	7 #5	4	P26	Major 6	4
P27	sus 2	3	P27	Major 7	4
P28	7 sus 4	4	P28	Major 7 b5	4
P29	Fourths	3	P29	Minor	7
P30	Intervall 0-0	2	P30	Minor 6	4
P31	Intervall 0-1	2	P31	Minor 7	4
P32	Intervall 0-2	2	P32	Minor harmonic	7
P33	Intervall 0-3	2	P33	Mode: Ionian	7
P34	Intervall 0-4	2	P34	Mode: Dorian	7
P35	Intervall 0-5	2	P35	Mode: Phrygian	7
P36	Intervall 0-6	2	P36	Mode: Lydian	7
P37	Intervall 0-7	2	P37	Mode: Mixolydian	7
P38	Intervall 0-8	2	P38	Mode: Aeolian	7
P39	Intervall 0-9	2	P39	Mode: Locrian	7
P40	Intervall 0-10	2	P40	Neapolitan major	7
P41	Intervall 0-11	2	P41	Neapolitan minor	7
P42	Intervall 0-12	2	P42	Nine Tone	9
			P43	Octatonic	8
U01-U16	User chords	1..12	P44	Oriental	7
			P45	Overtone	7
			P46	Pelog	5
			P47	Pentatonic	5
			P48	major Pentatonic	5
			P49	minor Pentatonic	5
			P50	Prometheus	5
			P51	Spanish	7
			P52	Symmetrical	8
			P53	Wholetone	6
			P54	leading Wholetone	7
			U01-U16	User scales	1..12



# 6. MENU LIST

## 6.1 Structure Arp/Bass List

LIST			
ARP	KN	KN	BASS
Ch:P01	C	C	Sc:P01
Ch:P09	C	D	Sc:P02
Ch:P02	#C	C	Sc:P03
Sc:U01	C	C	Sc:P01
Ch:U01	D	#D	Ch:P01
Ch:P21	E	E	Ch:U02
Ch:U16	#F	#F	Sc:P01
Ch:P01	C	#C	Sc:P01
Ch:P05	A	A	Sc:P02
Ch:P14	C	C	Sc:P01
Sc:P01	B	B	Sc:P05
Ch:U01	C	D	Sc:U01
Lenght: 1..12			

lenght of list

KN: KEYNOTES ARP + BASS  
 ARP: Memory chord or scale-Nr  
 BASS: Memory chord or scale-Nr

< list example

The CV-input LIST (0..5volt) can be easy control the both arpeggio tracks ARP and BASS. The 12 list places can be use for auto-playing different chords/scales of ARP and BASS track with seperatly keynotes (chord/scale sequencer).

0volt: - List deactivated  
 >0...+5volt: - List places 1..Lenght selectable

You can select a list place manually in menu LIST or in menu PLAYLIST (push note keys for select the place - see below)

In this case you can load different chords/scales and different keynotes at the same time for the ARP and BASS tracks.

Limit the size of the list for the CV-input LIST with "LENGHT".

### TRANSPOSE

The List can be transposed additional with the voltage from CV-input TRANSPOSE (12 semitones).

## 6.1 Edit Arp/Bass List

### Call MENU LIST:

Push down Key SHIFT and Key "A"

Change also the MAINMENU while push down and turn the data-entry-knob!

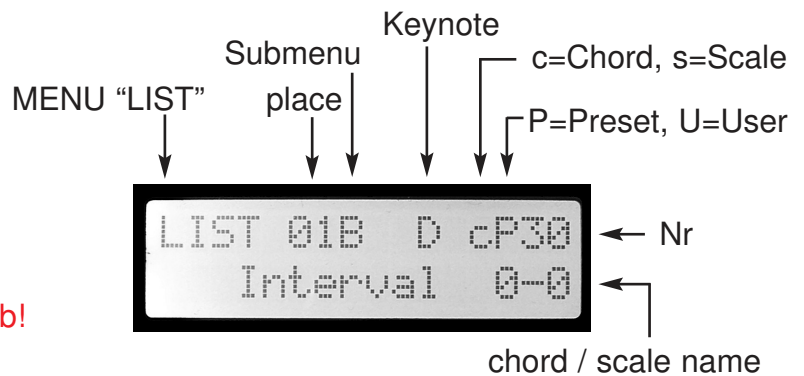

### Call SUBMENUs: "A" ARP, "B" BASS, "LENGHT" list lenght and set values:

Toggle between Submenu selection and value selection: Push data-entry-knob

Blink Submenu ON: you select the submenu of your choice by turning the data-entryknob

Blinking OFF: you select the parameter of your choice by turning the data-entryknob

Possible values:

A (ARP): chords cP01..cU16 or scales sP01..sU16

B (BASS): chords cP01..cU16 or scales sP01..sU16

Lenght: 1..12

### Place:

This is one of 12 list places. Select list place with note keys C-B.

On each place you can set seperatly the chord/scale/keynote for ARP and the chord/scale/key-note for BASS.

### Set the KEYNOTE:

Push and Hold down key "KEYNOTE " and push the key for set the Keynote. The LED of the key displays the Keynote.

You found the keynotes of ARP and BASS in the second row of the Keynote menu:



### Load Chord or Scale (Submenu A or B, Blinking OFF!):

Turn the data-entryknob.

Notes begins to load (automatically transposed) to the octave 1 of the modul keyboard.

You can see the notes on the LEDs of the keys.

While loading the "HOLD" will be set to "ON" automatically. You can clear all notes while set the "HOLD" function "OFF" : Push and hold down key SHIFT and HOLD. (Please note: This clear not the listplace - only the note buffer!)

### Submenu Lenght:

Limit the list places for the CV-Input LIST .

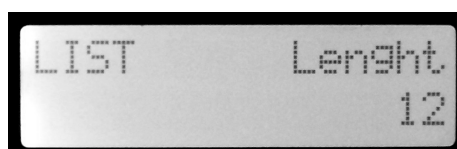

## 6.3 PLAYLIST MENU

### Call PLAYLIST MENU:

Push down key SHIFT and key "PLAYMODE"

Change also the MAINMENU while push down and turn the data-entry-knob!

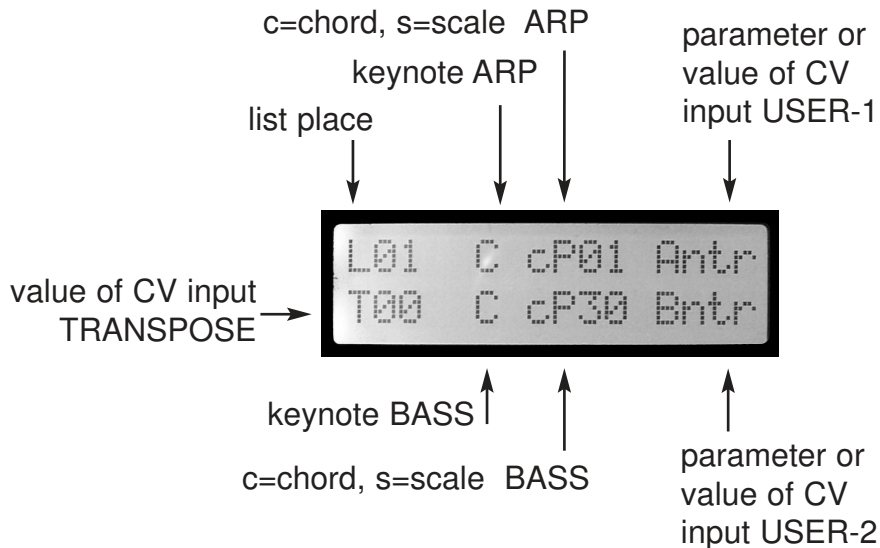

### L01..12 (list place)

This is one of twelve list places. Push down the keys C-B for calling one of the twelve list places. This loads the data (chord/scale/keynotes) of the list place. Also you can call the list places with the CV input "LIST" (activated by the CHORD trigger input).

### T00..12 (Transpose)

This is the value of the CV input "TRANSPOSE". 12 semitones are possible.

### Keynote

The second value in the top LCD row is the keynote of the ARP arpeggio of the selected list place. You found the keynote of the BASS arpeggio in the second LCD row.

### Chord/Scale

The next value in the top LCD row is the selected chord or the selected scale of the ARP arpeggio of the selected list place.

You found the selected chord or scale of the BASS arpeggio in the second LCD row.

c = Chord   s = Scale   P = preset   U = user

### Status of the USER 1 and 2 CV inputs

The last value in the top LCD row displays the parameter and the value of the CV input "USER-1" (alternately blinking of both parameter and value).

The last value in the second LCD row displays the parameter and the value of the CV input "USER-2" (alternately blinking of both parameter and value).



← parameter



← value

## 7. MENU SETUP

### Call MENU SETUP:

Push down Key SHIFT and Key SETUP ("F")

Change also the MAINMENU while push down and turn the data-entry-knob!

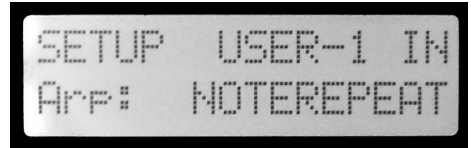

### Call SubMenus and set values:

Toggle between Submenu selection and value selection: Push data-entry-knob

Blink Submenu ON: you select the submenu of your choice by turning the data-entryknob

Blinking OFF: you select the parameter of your choice by turning the data-entryknob

### 7.1 TUNE-MODE

Set all CV-outputs of the module in UNISONO mode for better tuning connected oscillators.

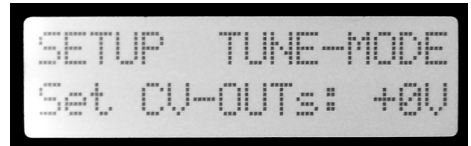

You can set the voltage on all CV output jacks in 1 volt steps from 0 to +5volt (note C in octave steps).

Advice: While the sequencer is run, the output setting is inactiv.

### 7.2 Setup USER-1/2 Inputs

Determines the function (parameter control) of the CV-inputs USER-1 and USER-2.

You can use the booth inputs for control different parameters of the arpeggiator channels ARP, BASS and XOUT.

USER-1 controls ARP, X-1, X-2, X-3 and X-4 parameters.

USER-2 controls BASS, X-5, X-6, X-7 and X-8 parameters.

>> You found the table of parameter overview on page 21 !

**Table of possible parameters:**

CV input USER-1		CV input USER-2	
parameter	short cut	parameter	short cut
Arp: Portamento	'Apor'	Bass: Portamento	'Bpor'
Arp: Noterepeat	'Antr'	Bass: Noterepeat	'Bntr'
Arp: Sequences all	'Aseq'	Bass: Sequences all	'Bseq'
Arp: Clock all	'AClk'	Bass: Clock all	'BClk'
Arp: Clock duple	'Aduo'	Bass: Clock duple	'Bduo'
Arp: Clock triplets	'Atri'	Bass: Clock triplets	'Btri'
Arp: Clock dots	'Adot'	Bass: Clock dots	'Bdot'
Arp: Gate	'Agat'	Bass: Gate	'Bgat'
Arp: Velocity 1..127	'V127'	Bass: Velocity 1..127	'V127'
Arp: Velocity Acc+Random	'Vrnd'	Bass: Velocity Acc+Random	'Vrnd'
X-1: Sequences all	'1seq'	X-5: Sequences all	'5seq'
X-1: Clock all	'1Clk'	X-5: Clock all	'5Clk'
X-1: Clock duple	'1duo'	X-5: Clock duple	'5duo'
X-1: Clock triplets	'1tri'	X-5: Clock triplets	'5tri'
X-1: Clock dots	'1dot'	X-5: Clock dots	'5dot'
X-1: Gate	'1gat'	X-5: Gate	'5gat'
X-2: Sequences all	'2seq'	X-6: Sequences all	'6seq'
X-2: Clock all	'2Clk'	X-6: Clock all	'6Clk'
X-2: Clock duple	'2duo'	X-6: Clock duple	'6duo'
X-2: Clock triplets	'2tri'	X-6: Clock triplets	'6tri'
X-2: Clock dots	'2dot'	X-6: Clock dots	'6dot'
X-2: Gate	'2gat'	X-6: Gate	'6gat'
X-3: Sequences all	'3seq'	X-7: Sequences all	'7seq'
X-3: Clock all	'3Clk'	X-7: Clock all	'7Clk'
X-3: Clock duple	'3duo'	X-7: Clock duple	'7duo'
X-3: Clock triplets	'3tri'	X-7: Clock triplets	'7tri'
X-3: Clock dots	'3dot'	X-7: Clock dots	'7dot'
X-3: Gate	'3gat'	X-7: Gate	'7gat'
X-4: Sequences all	'4seq'	X-8: Sequences all	'8seq'
X-4: Clock all	'4Clk'	X-8: Clock all	'8Clk'
X-4: Clock duple	'4duo'	X-8: Clock duple	'8duo'
X-4: Clock triplets	'4tri'	X-8: Clock triplets	'8tri'
X-4: Clock dots	'4dot'	X-8: Clock dots	'8dot'
X-4: Gate	'4gat'	X-8: Gate	'8gat'

You can see the parameters and values in the Playlist menu:  
alternately blinking of both parameter and value (see the short cuts in the table).

>> See below PLAYLIST MENU

## 8. MENU X-OUT

### Call MENU X-OUT:

Push down Key SHIFT and Key "G")

Change also the MAINMENU while push down and turn the data-entry-knob!

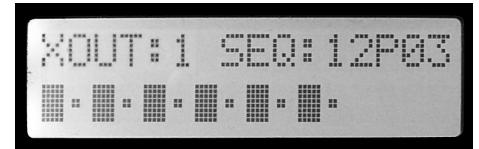

### Call SubMenus and set values:

Toggle between Submenu selection and value selection: Push data-entry-knob  
 Blink Submenu ON: you select the submenu of your choice by turning the data-entryknob  
 Blinking OFF: you select the parameter of your choice by turning the data-entryknob.

Following values are possible for each x-out:

**SEQ-16P00..15U08** - 63 preset + 63 user sequence pattern >> see page 11+12!

**CLOCK** - Clockdivider value (intern oder extern Clock / Midiclock)

**GATE** - Gatetime of the steps

(CLOCK and GATE not available, if SYNC=Arp+Bass Trigger)

**Pattern 16P00:** mirrored sequence (of the oppsite track)

**Pattern 16P01:** switch OFF the X-out channel (all steps off).

**Pattern 16P03:** plays each steps.

Start/Stop sequencer with key PLAYMODE (but for external MIDI clock).

**ADVICE!** You can't edit sequence pattern in this menu! Please edit sequences in menu ARP SEQ or BASS SEQ. (>> see page 12)

**GATE** (Not available, if SYNC=Arp+Bass Trigger)

GATE is the time between Note-On and Note-Off.

The GATE time values are adapted in relation to the Clock of the sequence ("adapted").

Following values are always definitely:

adapted: 1 GATE time is always the time of 1 tick.

adapted: 8 GATE time is always the time of value CLOCK of the sequence.

With "adapted:8" you can play notes without note off (bonded):



### XOUT MIDI NOTEN

Each XOUT channel sends one fix MIDI note:

output	MIDI note	output	MIDI Note
X-1	36	X-5	48
X-2	37	X-6	59
X-3	60	X-7	61
X-4	63	X-8	62

## 9. MENU MIDI

### Call MENU MIDI:

Push down Key SHIFT and Key MIDI ("E")

Change also the MAINMENU while push down and turn the data-entry-knob!

### Call SubMenus and set values:

Toggle between Submenu selection and value selection: Push data-entry-knob

Blink Submenu ON: you select the submenu of your choice by turning the data-entryknob

Blinking OFF: you select the parameter of your choice by turning the data-entryknob

#### 1. TEMPO

Sets the basic tempo of the arpeggiator of  
Tempo 20..255 bpm. If SYNC="extern MidiClock"  
then the value is "extern".



#### 2. SYNC

Set the Basic clock source: Internal or external clock.

**extern MidiClock:** external MIDI-Clock

**intern Clock:** internal MIDI-Clock

**Chord Trigger In:** external Trigger Clock 96 Ticks per bar

**Arp+Bass Trig In:** Stepsequencer mode:

- ARP per ARP-Trigger Input

- BASS per BASS-Trigger Input

- X-OUT per CHORD-Trigger Input

- Reset per CONVERSE-Input or per Key PLAYMODE



#### 3. RECV CLOCK

Set the MIDI clock divider on/off

**HALF:** MIDI-Input-Clock Divider on **NORMAL:** off

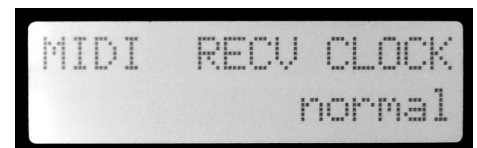

#### 4. SEND CLOCK

Set following values:

**OFF:** - transmitted clock off

**NORMAL:** - transmitted clock (normal)

**HALF:** - transmitted clock with half speed  
(MIDI clock out divider is on)

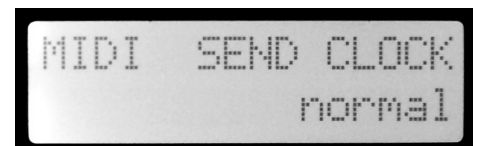

#### 5. MIDI CHANNEL

MIDI RECV CHAN - MIDI received channel

MIDI ARP CHAN - Transmitted channel ARP Arpeggio

MIDI BASS CHAN - Transmitted channel BASS Arpeggio

MIDI CHORD CHAN - Transmitted channel CHORD

MIDI X-OUT CHAN - Transmitted channel X-OUT notes

## Table of MIDI- controllers

(Control changes):

MIDI-Controller number	Parameter
20	Arp: GLIDE
21	Arp: GATE
22	Arp: NOTEREPEAT
23	Arp: MODE
24	Arp: RANGE
25	Bass: GLIDE
26	Bass: GATE
27	Bass: NOTEREPEAT
28	Bass: MODE
29	Bass: RANGE

## Splitzone external MIDI-Keyboard



## Splitzone for separately / simultaneous playing of ARP- and BASS-Arpeggio

### Arpeggio-BASS

Received notes (4 Octaves) in range of 12..59 creates BASS-Arpeggio-notes.

### Arpeggio-ARP

Received notes (4 Octaves) in range of 36..83 creates ARP-Arpeggio-notes.

### CHORD

Received ARP-arpeggio-notes creates also the 4-notes chord.

### Advice:

For "normal" playing of arpeggios per external MIDI keyboard switch HOLD off (push down keys SHIFT and HOLD).



# 10. Appendix

## Technical details

**Current consumption:** ca. +180mA / -20mA

**Size:** Arpeggiator-2013: Euro format 3U / 15HP 76 x 128,5 x 50mm  
X-2013: Euro format 3U / 6HP 30 x 128,5 x 35mm

## Warrenty

Beginning from the date of purchase a 2-year warranty is guaranteed for this device in case of any manufacturing errors or other functional deficiencies during runtime. The warranty does not apply in case of:

- damage caused by misuse
- mechanical damage arising from careless treatment (dropping, vigorous shaking, mishandling, etc)
- damage caused by liquids penetrating the device
- heat damage caused by overexposure to sunlight or heating
- electric damage caused by improper connecting  
(wrong power supply/ jacks/ MIDI connections/ voltage problems).

If you have any complaints please contact your dealer or send an e-mail to:  
service@flame.fortschritt-musik.de

## Terms of production

conformity: CE, RoHS, UL

## Disposal

The device is produced with RoHS-conformity (subject to the regulations of the European Union) and is free of hazardous substances (like mercury, plumb, cadmium and hexavalent chrome). But electronical scrap is hazardous waste. Please don't add this to consumer waste. For an environment friendly disposal of waste please contact your distributor or specialist dealer.

## Support

Updated and additional informations, updates, downloads and more see:  
<http://flame.fortschritt-musik.de>

## Acknowledgment

For help and assistance big thanks to: Schneiders Büro Berlin, Shawn Cleary (Analogue haven, Los Angeles), Robert Junge, Anne-Kathrin Metzler, Lena Büniger and a very big thanks to Ebotronix (for Support, Betatest etc.).